

KEY BOX

USER MANUAL

What's Included

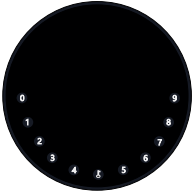

1 x KeyBox



1 x HELLO Card

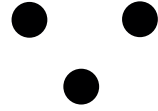

3 x Screw Caps

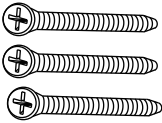

3 x Mounting Screws

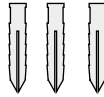

3 x Screws Anchors



1 x Reset Tool

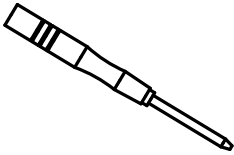

1 x Screw Driver

Specification

Model	Safe X / Safe X Plus
Material	Body Zinc Alloy, SUS304
Battery	4 x AAA Alkaline Battery
Unlock Mechanism	Bluetooth, PIN Code, App
Jump Start	USB-C

Front

Inside

Back

120mm (4- 7/10'')

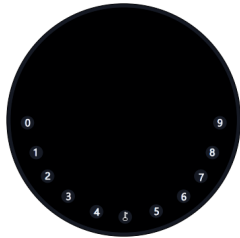

120mm (4- 7/10'')

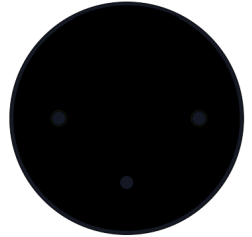

120mm (4- 7/10'')

Depth
22mm (4/5 '')

120mm (4- 7/10'')

Features

Lock&Unlock



Administrator Unlock

Set a Master Administrator PIN for Unlocking, settings, operations etc. and only the administrator could change the administrator PIN code.



Anti-peeping

Add up to 10 digits before and after PIN code to intensify your PINs.

Mobile Control



Bluetooth Unlock

With your Mobile you could unlock the KeyBox by Swiping the "👉" to the right.



Mobile Administrator

Set Administrator PIN Codes from your Mobile to unlock, add users, delete users, etc.

Battery



Battery Life

4 AAA batteries, the life cycle will be more than 12 months, please use good batteries.



Low Consumption

BLE broadcasting turns to sleep mode if no operations.

Emergency



Jump Start

When the power is down and use USB-C to jump start the lock and get it unlocked



System Lockdown

The lock will be lockdown for 5 minutes if continuously enter wrong PINs for 5 times.



User Unlock

This KeyBox allows to add up to 100 user PIN codes for your family, friends and visitors.



Auto Locking

If there are no opening motion in 10 seconds the box will be automatically locked.



Offline Unlock

You could generate offline code through mobile App, for scheduled access, parcel delivery, housekeeping, etc.



OTA Upgrade

Upgrade online, Fix bugs, Update functions and optimize user experience.



Low Battery

When the battery runs out of power, system will remind you to replace the batteries.

Quick Start

Step 1 > Install Battery

>. Remove the (4) screws on the battery cover

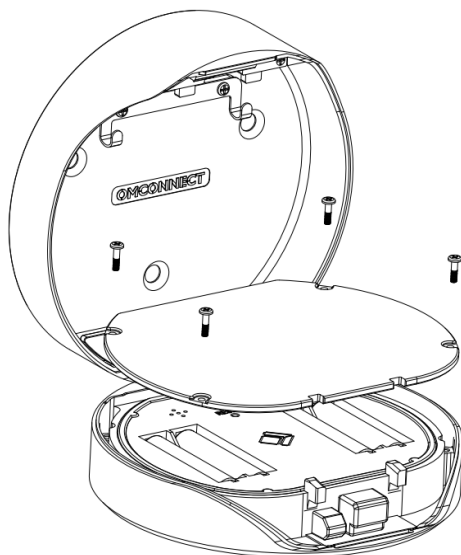

>. Put 4 AAA batteries into the battery dock.

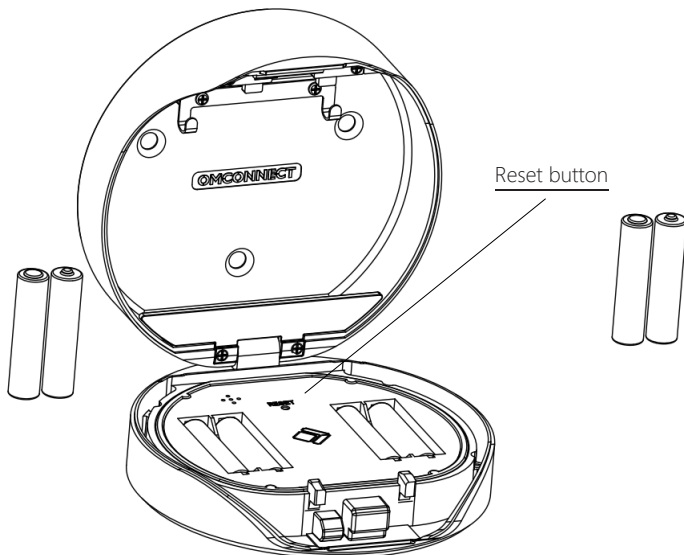

Step 2>Change Admin Password-Initial Admin Password:123456

>1. Press **↵** and hold for 3 beeps

>2. Right after the 3 beeps please key in:

Initial Admin Password + **↵**+new admin password+ **↵**+new admin password+ **↵**

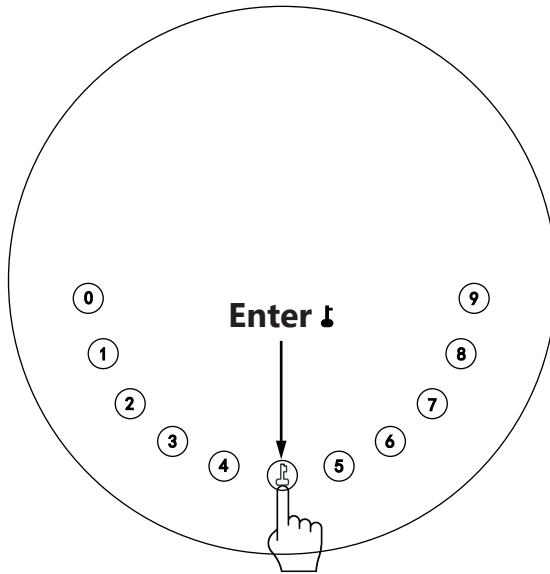

Step 3>Download Mobile App

>1. Scan QR Code below and download the App and turn on your mobile Bluetooth, you can also choose to download other App supported by Tuya.



Step 4>Add Device

Activate Bluetooth to enter pairing mode

> 1. Press **🔑** +9+ **🔑** and enter Admin password + **🔑** , when the light slowly blinks in blue the KeyBox is ready to pair.

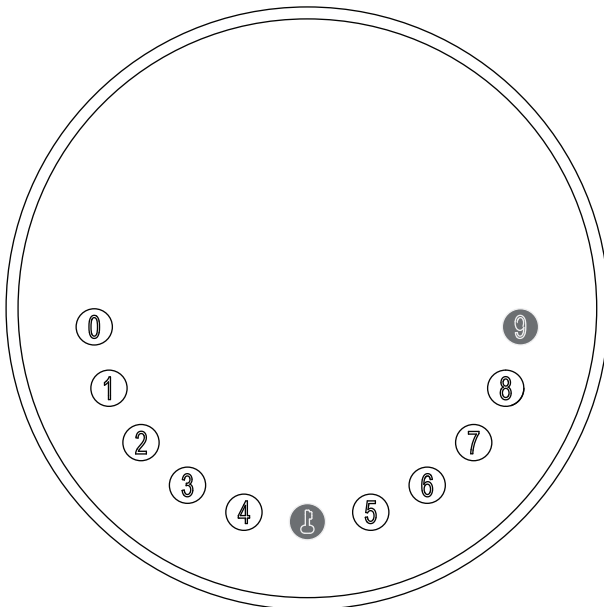

>2. Go to App Home page, click Add Device or click "+" on the upper right.

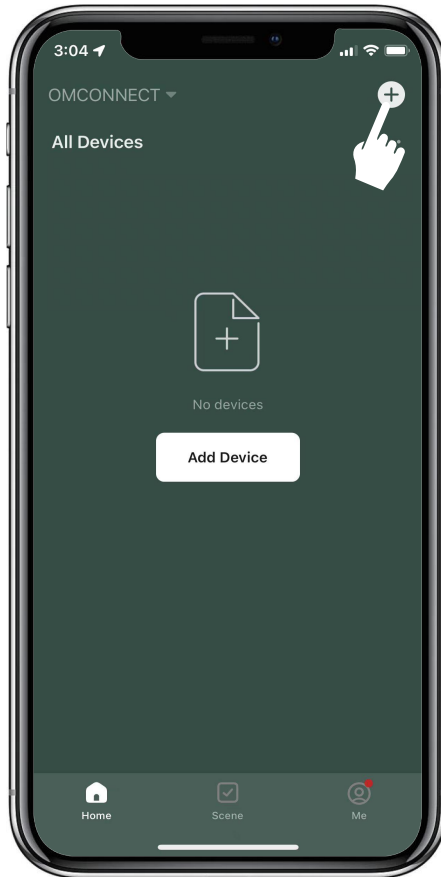

>3. You will see the detected device and click "Add".

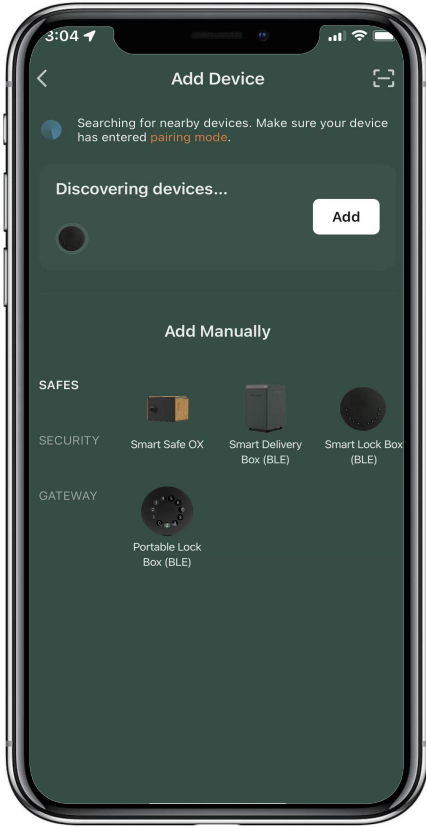

>4. Connecting, you need to wait for a few seconds to let it finish.

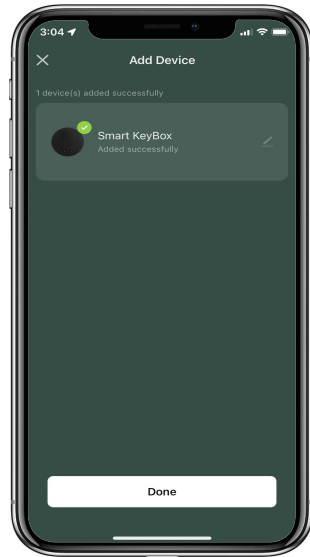
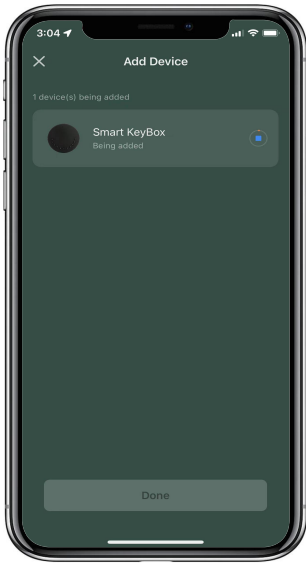

>5. Device added

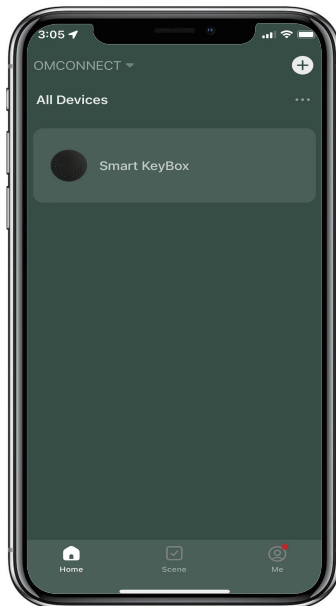

Mechanical Instructions

Password & Factory Mode:

1. Password Length

Password must be 6 digits (no more or less)

2. Add User Password

Press **⏏** + 0 + **⏏** until the blue light blinks

> . Enter admin password + **⏏**

> . Enter new user password + **⏏**

> . Enter new user password again and press **⏏**

> . When the **⏏**(Enter button) blinks in green, user password has been set.

3. Delete User Password

Press **⏏** + 2 + **⏏** until the blue light blinks

> . Enter admin password and press **⏏**

> . Enter the user password you wish to delete and press **⏏**

> . Enter the user password again and press **⏏**

> . When the **⏏**(Enter button) blinks in green the password has been deleted.

4. Delete All User Passwords

Press **⏏** + 00000 + **⏏** until the blue light blinks

> . Enter admin password and press **⏏**

> . When the **⏏**(Enter button) blinks in green all passwords have been deleted.

5. Virtual digits-Anti Peeping

Add any digits before and after the correct password the KeyBox unlock as always

6. System Lockdown

KeyBox will Lockdown for 5 minutes if entering wrong password continuously 5 times

7. Reset Factory Mode

Press and hold the reset button for 5 seconds and with a long beep

Bluetooth broadcasting & re-connecting:

Bluetooth broadcasting will turn to sleep mode if no operation within 1 minute.

Press any key to activate the Bluetooth, App&Device will get reconnected each other.

App Instructions

How to unlock:

- ☑ You will see all devices on the home page.
- ☑ Tap the Smart Key Box to start operating.

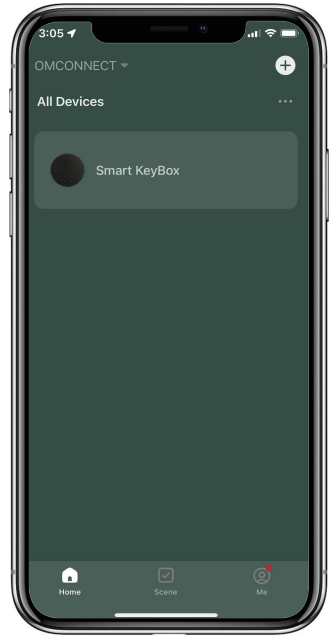

- ☑ Swipe the  to the right to unlock.

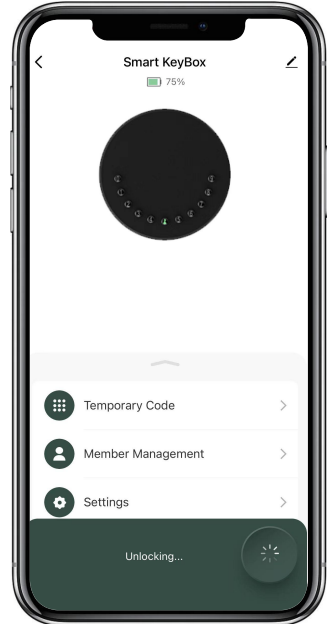
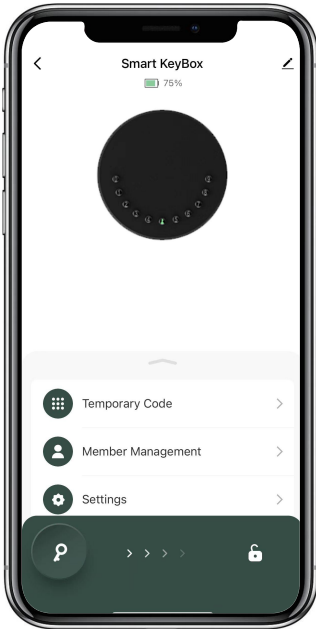

How to get Temporary code:

☑ Tap “Temporary Code”, there are a variety of codes for you to choose from:

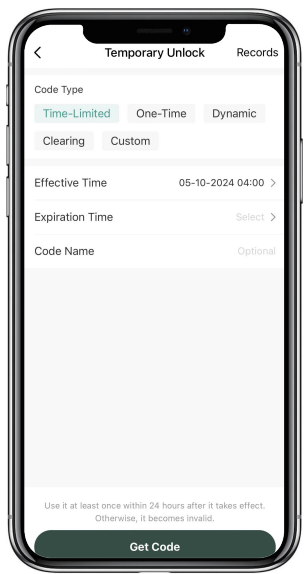
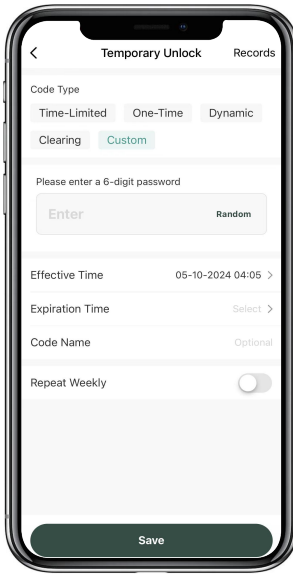
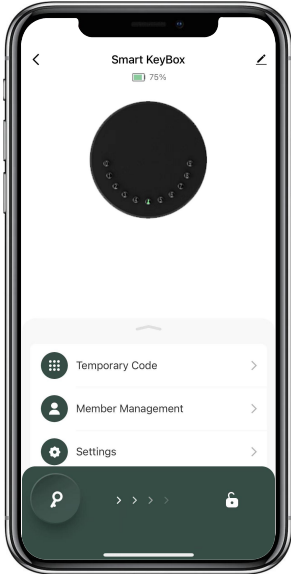

☑ Click on the password type you want to choose to set up and Tap “Save” or “Get Code”

☑ Tap “OK” to confirm and also can Tap “Share” to share this code with family or friend.

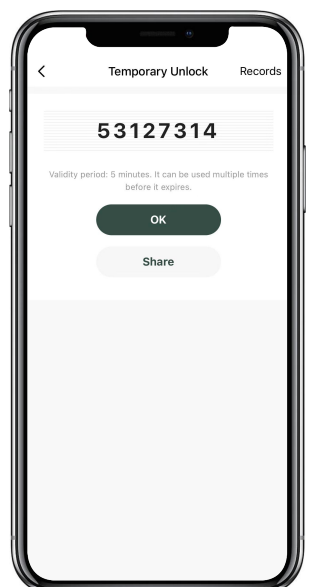
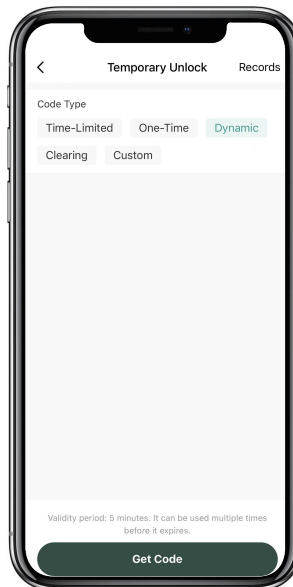
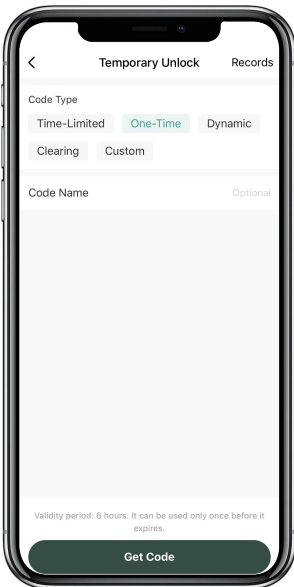

How to add Members:

☑ Tap "Member Management" to add family member or others.

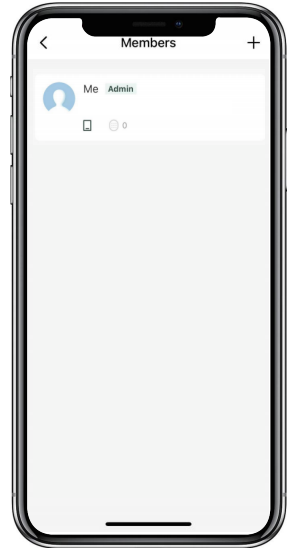
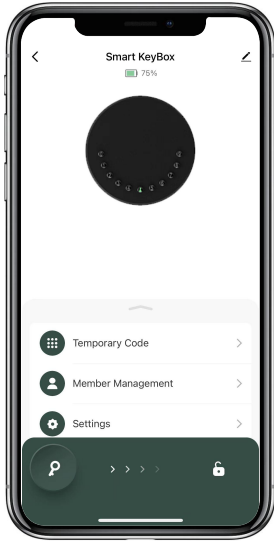

☑ Tap "+" to add member and edit member's information and save.

☑ Member will receive an invitation on the App, after he/she accept it, Admin can find the member in the list.

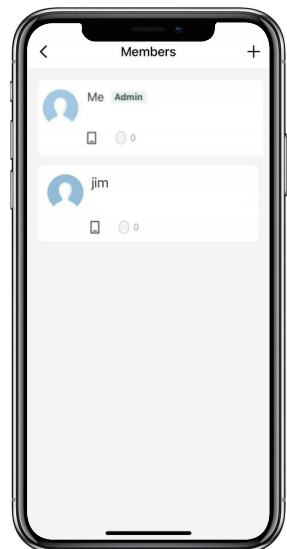
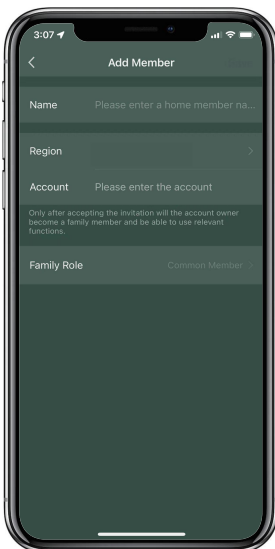

How to add Permanent code:

☑ Tap the Admin "Me" to add Permanent code.

☑ Tap "Add" to enter the Permanent code you want to set or get Random Permanent code and save.

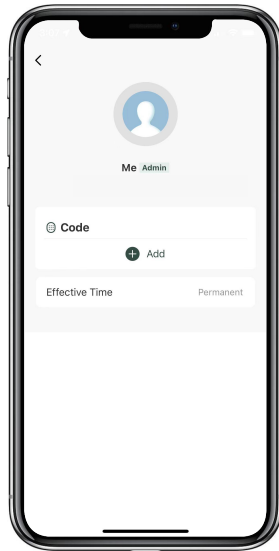
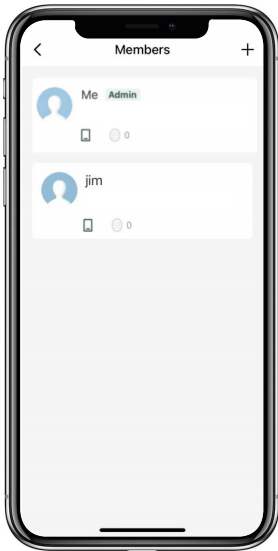

☑ You are able to use the Permanent code to unlock the device.

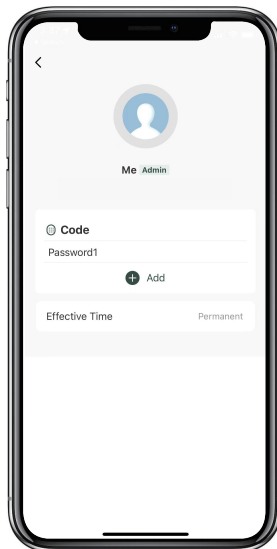

How to manage Members:

☑ Tap the Member you want to manage.

☑ Tap "Add" to set the Permanent code for the Member and save.

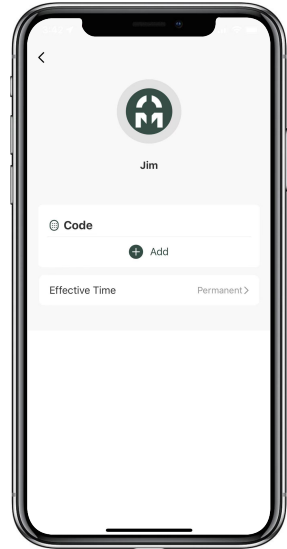
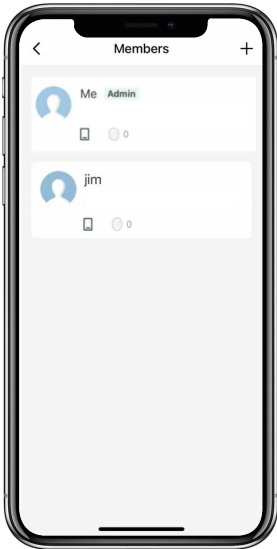

☑ Tap "Effective Time" to set this Member is Permanent or Custom and save.

☑ Set the validity period of Custom Member(Year/Month/Day/Hour/Minute).

☑ Members have no permission to access admin.

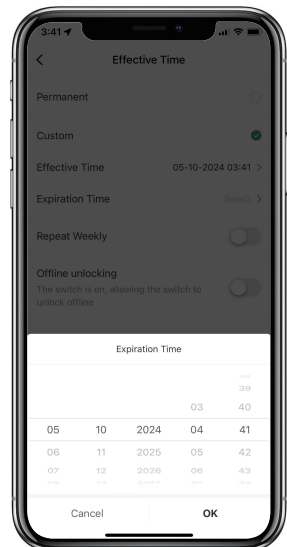
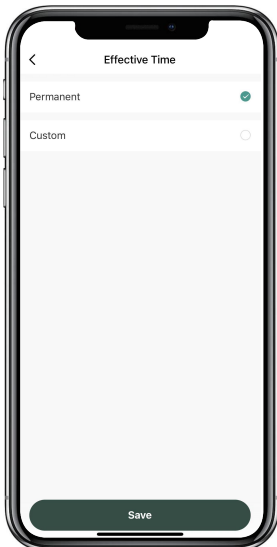

How to check Opening Log:

☑ Tap  to check the Log.

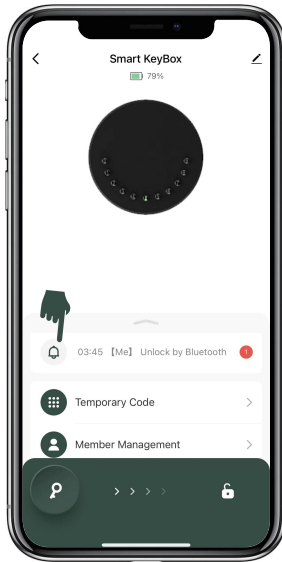

☑ You will find out when and whom opened the Keybox.

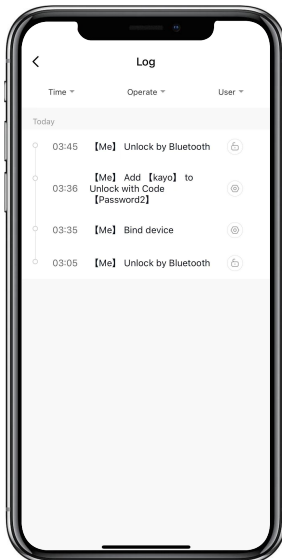

OMUARK
WWW.OMCONNECT.COM / WWW.OMUARK.COM