

USER MANUAL

Smart Safe OX & OX Pro

What's Included

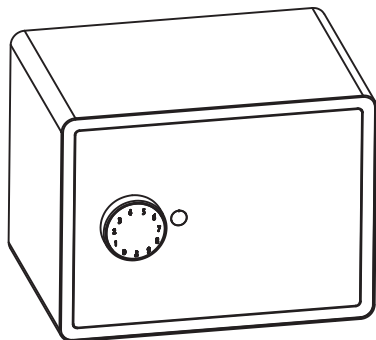

Smart Safe OX x 1

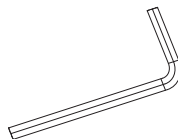

M6 Screw Driver x 1

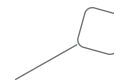

Reset Tool x 1

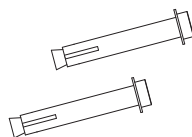

M6 Wall-Mount Screw x 2

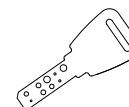

Mechanical Key x 2



Hello Card x 1

Specification

Model	OX & OX Pro
Material	Galvanized steel
Battery	4×AA Battery
Unlock Mechanism	Bluetooth, PIN Code, App, Mechanical Key

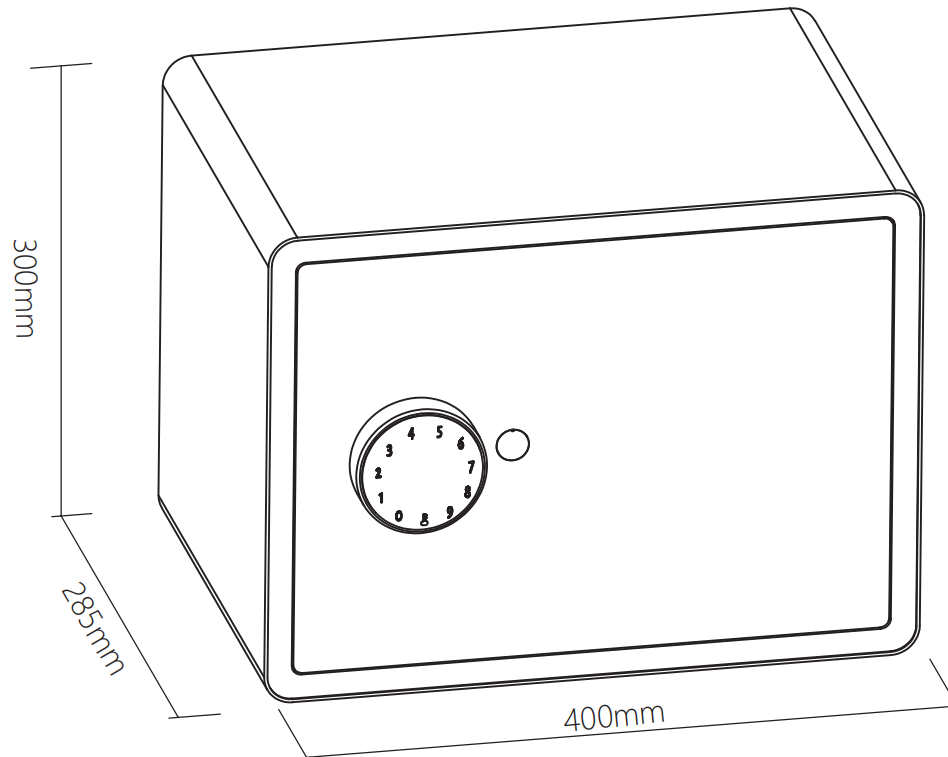

Features

Lock&Unlock



Administrator Unlock

Set a Master Administrator PIN for Unlocking, settings, operations etc. And only the administrator could change the administrator PIN code.

Mobile Control



Bluetooth Unlock

With your Mobile app you could unlock the Safe by swiping the  to the right.



Mobile Administrator

Set Administrator PIN Codes on your Mobile to unlock, add members, delete members, etc.

Battery



Battery Life

The battery lifetime will be 12 months for operating.



Low Consumption

BLE broadcasting turns to sleep mode if no operation.

Burglar Alarm



The alarm will be activated if anyone attempts to destroy the Safe, and the High decibel buzzer will be turned on.

Emergency



Emergency Unlocked

When the power is down, we can use Mechanical Key to open the Safe.



User Unlock

This Smart Safe allows to add up to 200 user PIN codes for your family and friends.



Remote Sharing

You could generate offline code through mobile App and let your friends and family access the Safe.



Low Battery

When the batteries run out of power, system will remind you to replace the batteries.



System Lockdown

The lock will be lockdown for 5 minutes if continuously enter wrong passwords for 5 times.

Installation

>. Please use the 2 mounting screws to fix the safe on your wall or cabinet.

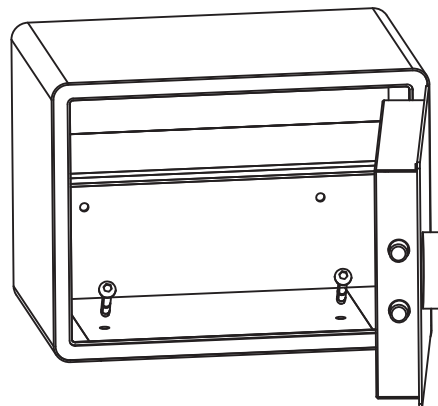
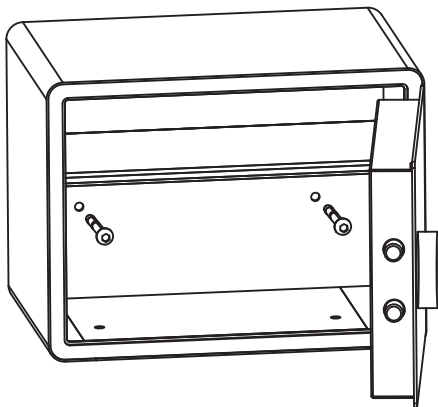

Quick Start

Step 1 > Install Battery

>. Put 4 × AA Battery into the battery dock.

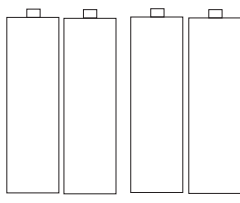

Reset Button

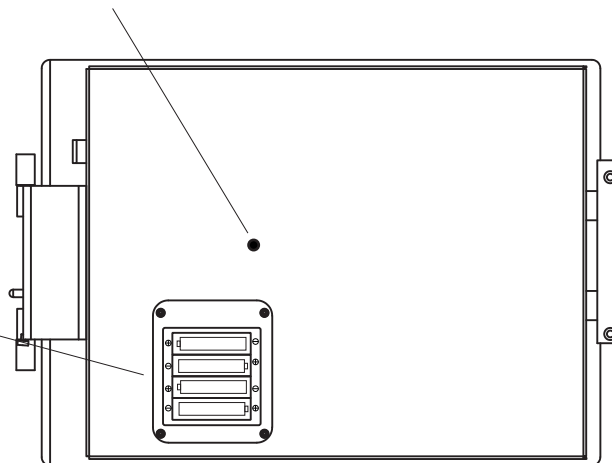



Step 1 > Change Admin Password-Initial Admin Password:123456

Administrator is required to reset the admin code before adding other user codes.

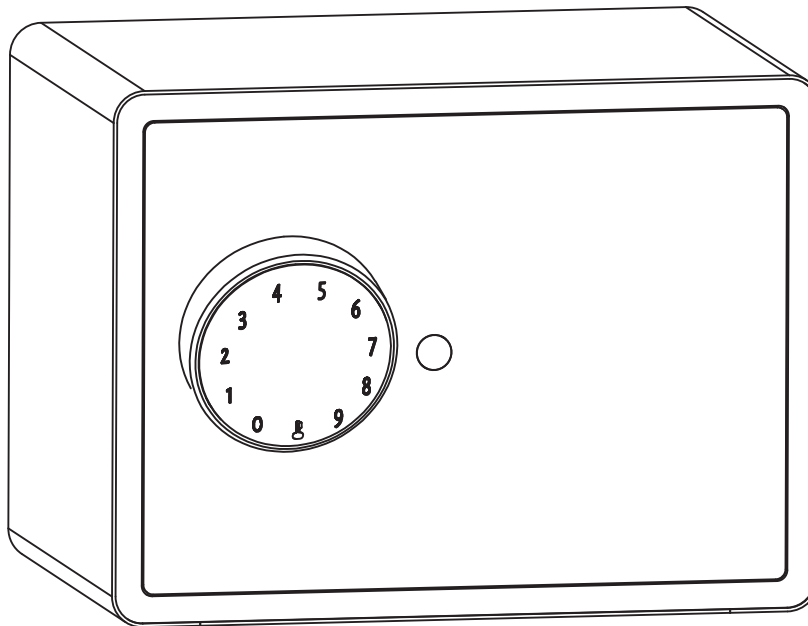
>1. Tap  and hold for 3 seconds and release, you will be hearing a confirmation sound.



>2. Right after the a confirmation sound please key in:

Initial admin code+ + new admin code+ +new admin code again+ , when you hear a confirmation sound the admin code has been changed.

Step 2>Download Mobile App

>1. Scan QR Code below to download the App and turn on your mobile Bluetooth. You can also choose to download other App supported by Tuya.



Step 3>Add Device

Activate Bluetooth to enter pairing mode

> 1. Tap 🔑+ 9 + 🔑+ admin code + 🔑, when you see the light slowly blinks in blue then you are ready to pair

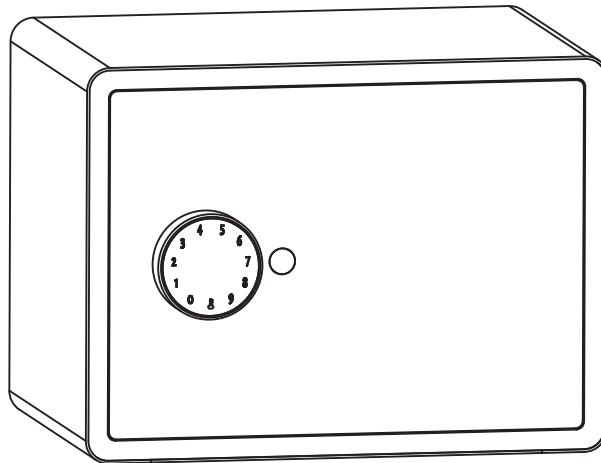

>2. Go to App Home page, click "Add Device" or click "+" on the upper right.

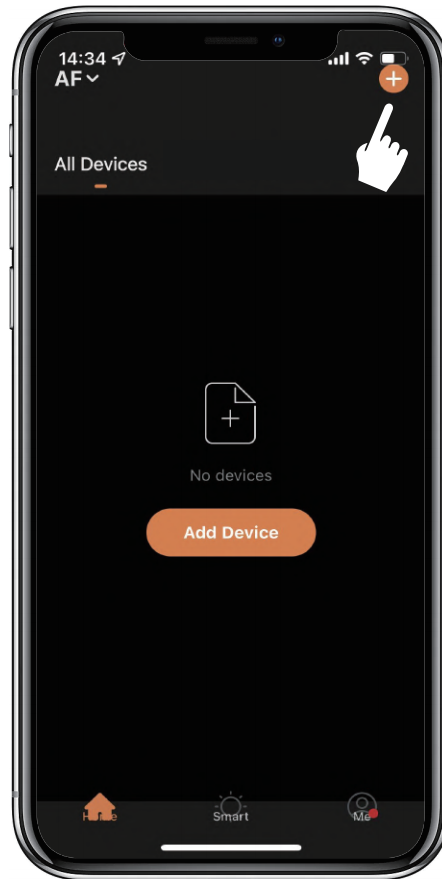

>3. You will see the detected device and click "Go to add".

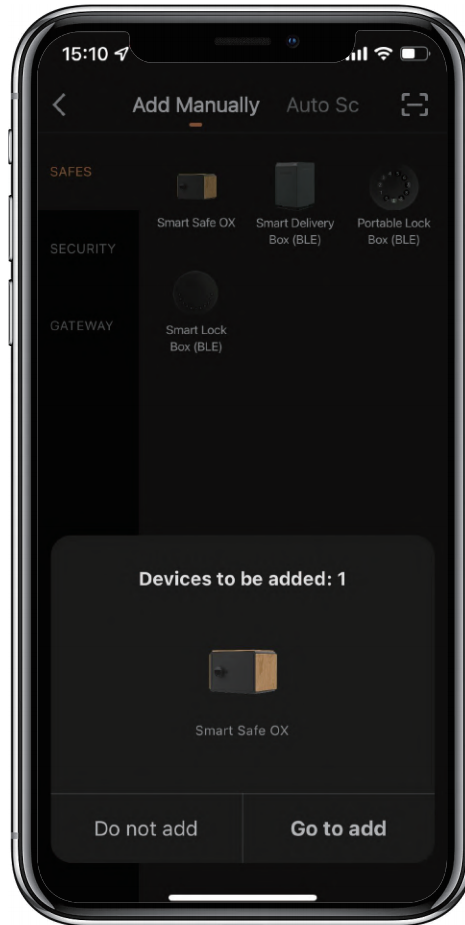

>4. Connecting, you need to wait for a few seconds to let it finish.

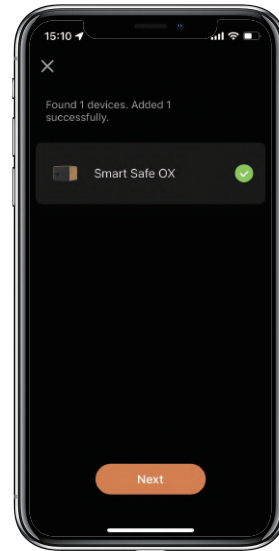
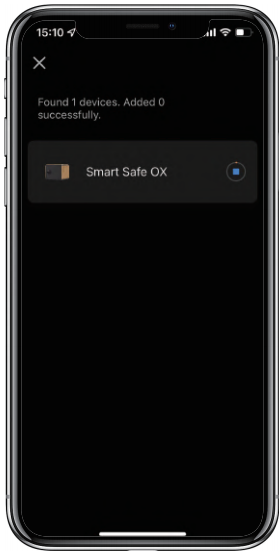

>5. Device added

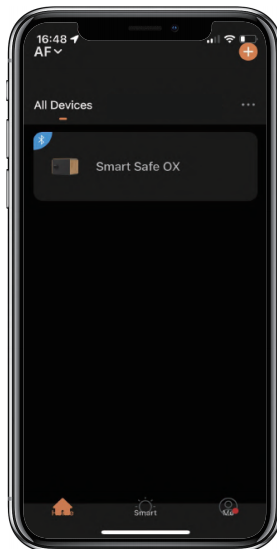

Mechanical Instructions

Password & Factory Mode:

Administrator is required to reset the admin code before adding other user codes.

1. Password Length

☒ Password must be 6 digits (no more or less)

2. Add User Password

- ☒ Tap **⏏** + 0 + **⏏** until the blue light blinks
 - > . Enter admin password + **⏏**
 - > . Enter new user password + **⏏**
 - > . Enter new user password again and press **⏏**
 - > . When the **⏏** (Enter button) blinks in green, user password has been set.

3. Delete User Password

- ☒ Tap **⏏** + 2 + **⏏** until the blue light blinks
 - > . Enter admin password and press **⏏**
 - > . Enter the user password you want to delete and press **⏏**
 - > . Enter the user password you want to delete again and press **⏏**
 - > . When the **⏏** (Enter button) blinks in green the password has been deleted.

4. Delete All User Passwords

- ☒ Tap **⏏** + 00000 + **⏏** until the blue light blinks
 - > . Enter admin password and press **⏏**
 - > . When the **⏏** (Enter button) blinks in green, all user passwords have been deleted.

5. System Lock-down

☒ The Smart Safe will Lock-down for 5 minutes if entering wrong password continuously 5 times.

6. Virtual digits-Anti Peeping

☒ Add any digits before and after the correct password the Safe unlock as always.

7. Reset Factory Mode

☒ Use the reset tool press and hold the reset button for 5 seconds until a long beep.

Bluetooth broadcasting & re-connecting:

☒ Bluetooth will turn to sleep mode and lights out if no operations within 1 minute.

☒ Tap any key to activate the Bluetooth, App & Device will get reconnected each other.

App Instructions

How to unlock:

- ☑ You will see all devices on the home page.
- ☑ Tap the Smart Safe OX to start operating.
- ☑ Swipe the 🔑 to the right to unlock.

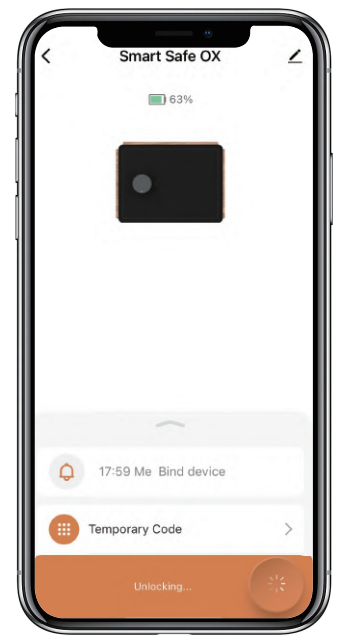
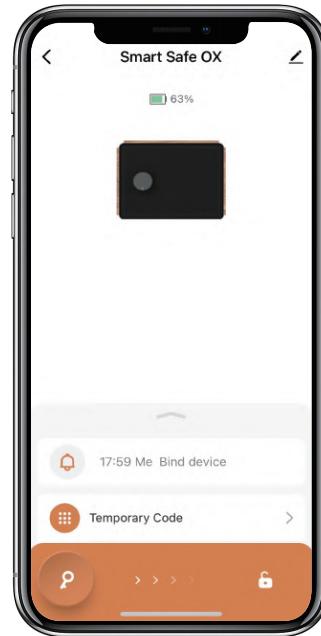
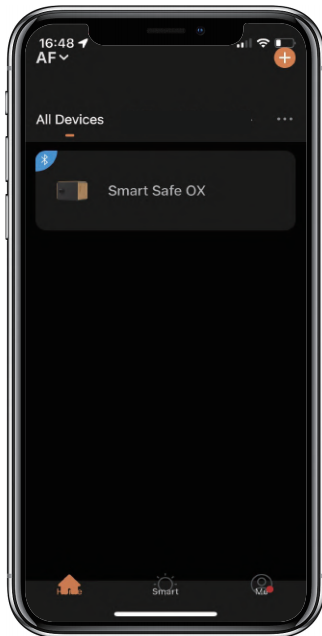

How to get Temporary code:

- ☑ Tap "Temporary Code"
- ☑ Tap "Obtain Password" to get Dynamic code which is valid for 5 minutes.
- ☑ Tap "OK" to confirm and also can Tap "Share" to share this code with family or friend.

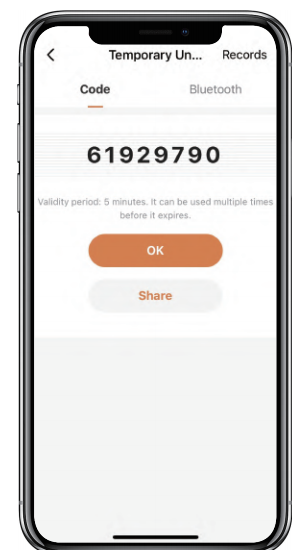
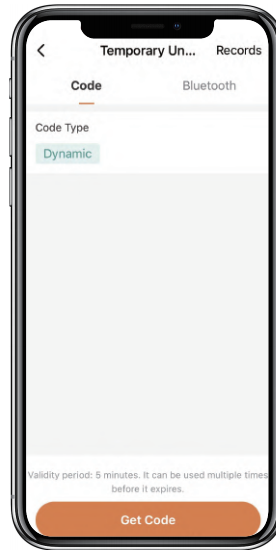
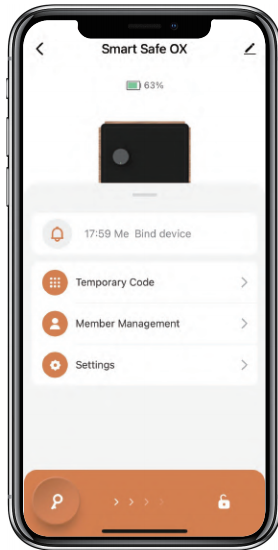

How to add Members:

- ☑ Tap "Member Management" to add family member or others.
- ☑ Tap "+" to add member and edit member's information and save.
- ☑ Member will receive an invitation on the App, after he/she accept it, Admin can find the member in the list.

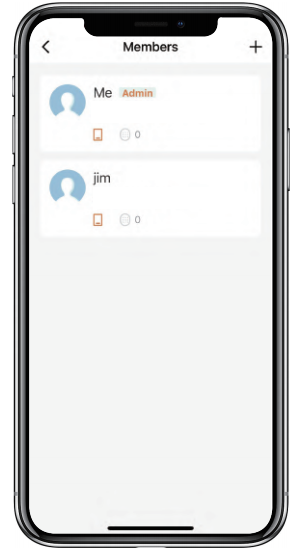
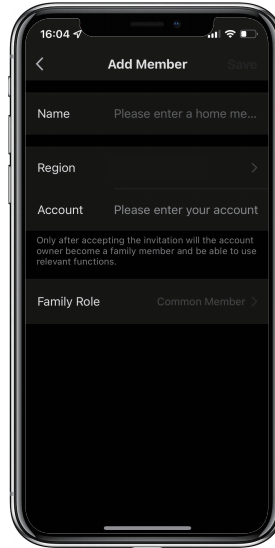
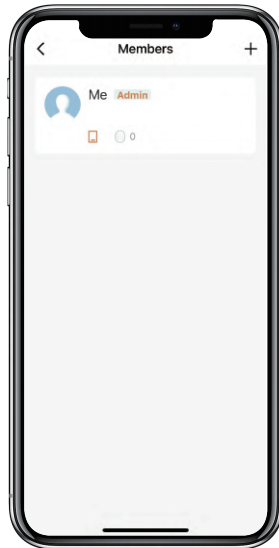
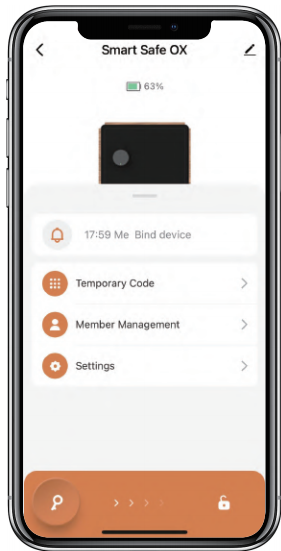

How to add Permanent code:

- ☒ Tap the Admin "Me" to add Permanent code.
- ☒ Tap "Add" to enter the Permanent code you want or get Random Permanent code and save.
- ☒ You are able to use the Permanent code to unlock the Safe.

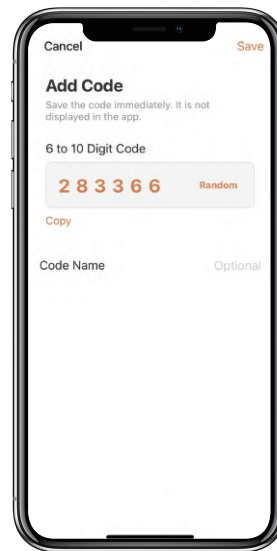
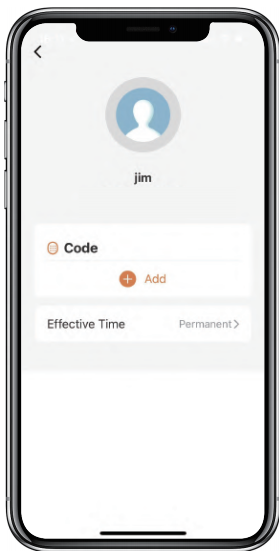
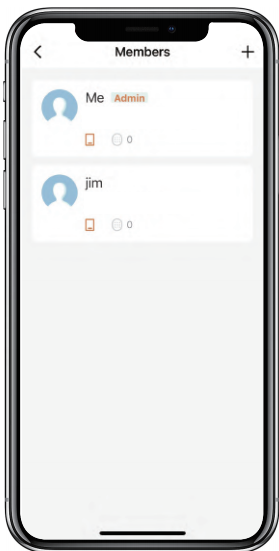

How to manage Members:

- ☑ Tap the Member you want to manage.
- ☑ Tap "Add" to set the Permanent code for the Member and save.
- ☑ Tap "Effective Time" to set this Member is Permanent or Custom and save.
- ☑ Set the validity period of Custom Member(Year/Month/Day/Hour/Minute).
- ☑ Members don't have access to Admin.

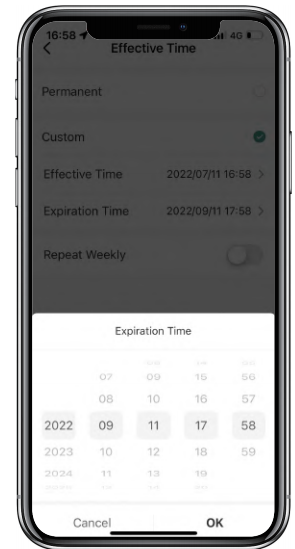
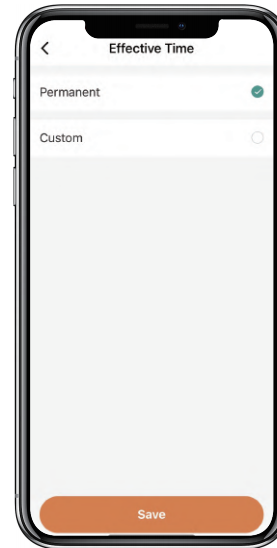
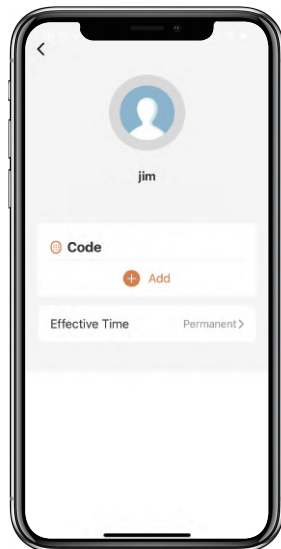
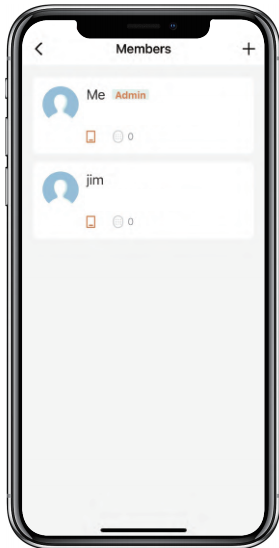

How to check Opening Log:

☒ Tap  to check the Log.

☒ You will find out when and whom opened the Safe.

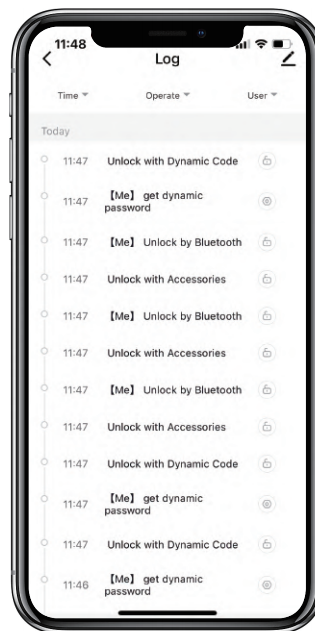
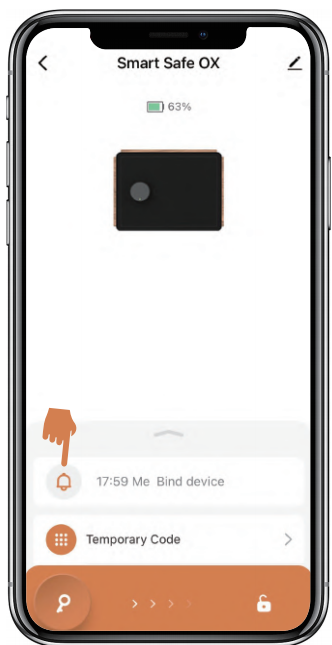

How to enable Alarm :

- ☒ Tap "Settings" to enable the "Arm Away"
- ☒ The alarm will be triggered if anyone attempts to destroy the Safe

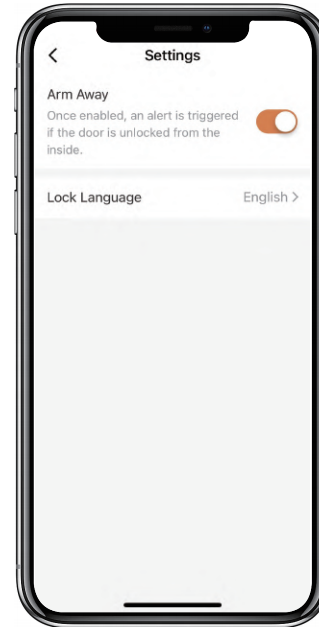
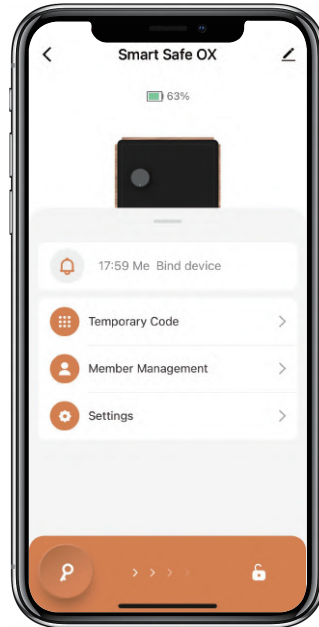

Gateway Instructions

If you have a Gateway supported by Tuya, it is available to connect the Gateway with our App.

- ☒ With the Gateway, you will receive the notification on time via the internet when the alarm is triggered.

How to enable Remote Unlock :

- ☒ Tap "Settings" to enable the "Remote Unlock"
- ☒ You will be able to unlock the Safe remotely via the internet.

OMUARK
WWW.OMCONNECT.COM / WWW.OMUARK.COM