

SOLO *SERIES*
USER MANUAL v1.0

What's Included

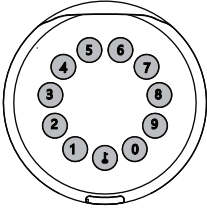

1 x Solo LockBox

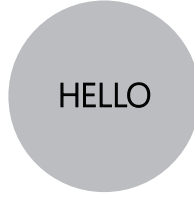

1 x HELLO Card

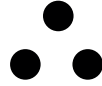

3 x Screw Cap



3 x Mounting Screws

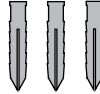

3 x Screws Anchors



1 x Reset Tool

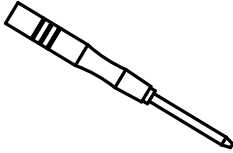

Screw Driver x 1

Specification

Model	Solo
Material	Body Zinc Alloy, SUS304
Battery	4 x AAA Alkaline Battery
Unlock Mechanism	Bluetooth, PIN Code, App
Jump Start	USB-C

Front

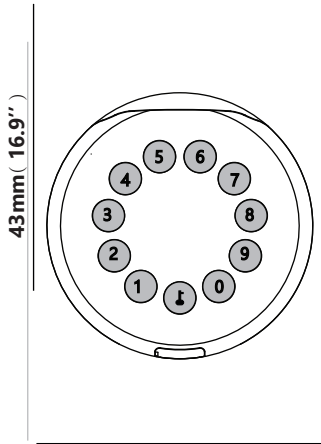

Inside

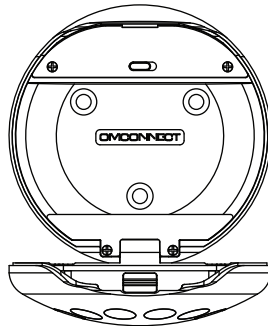

Back

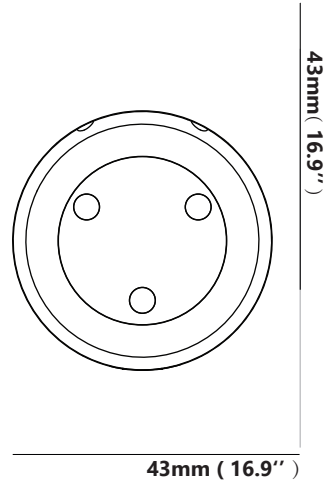

43mm (16.9")

Features

Lock&Unlock



Administrator Unlock

Set a Master Administrator PIN for Unlocking, settings, operations etc. and only the administrator could change the administrator PIN code.



Anti-peeping

Add up to 10 digits before and after PIN code to intensify your PINs.



User Unlock

This LockBox allows to add up to 100 user PIN codes for your family, friends and visitors.



Auto Locking

If there are no opening motions in 10 seconds the box will be automatically locked.

Mobile Control



Bluetooth one-touch unlock

With your Mobile you could unlock the LockBox by tapping the "🔒" on the App.



Offline Unlock

You could generate offline code through mobile App, for scheduled access, parcel delivery, housekeeping, etc.



Mobile Administrator

Set Administrator PIN Codes from your Mobile to unlock, add users, delete users, etc.

Battery



Battery Life

4 AAA batteries, the life cycle will be more than 12 months, please use good batteries.



Low Battery

When the battery runs out of power, system will remind you to replace the batteries.



Low Consumption

BLE broadcasting turns to sleep mode if no operations.

Emergency



Jump Start

When the power is down and use USB-C to jump start the lock and get it unlocked



System Lockdown

The lock will be lockdown for 5 minutes if continuously enter wrong PINs for 5 times.

Quick Start

Step 1 > Install Battery

>1. Remove the battery cover

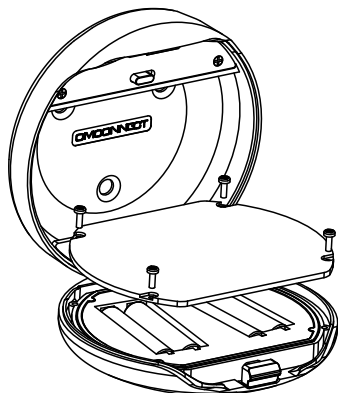

>2. Put 4 AAA batteries into the battery dock.

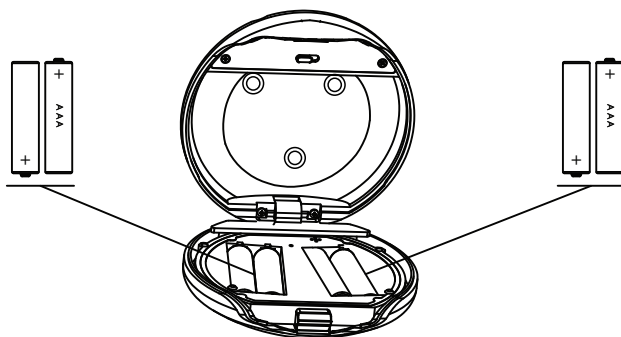

Step 2>Download Mobile App

>1. Scan QR Code below and download the App and turn on your mobile Bluetooth



Step 3>Add Device

>1. Go to App Home page, click Add Device or click "+" on the upper right.

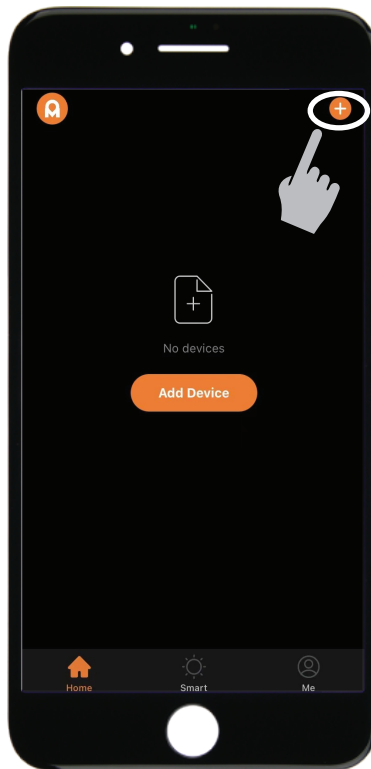

> **2.** Press **⏻** + **9** + **⏻** + admin code and press **⏻** to activate the Bluetooth and start pairing.

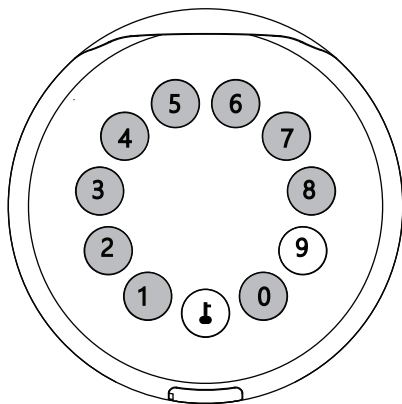

>3. You will see the detected device and click "Go to add".

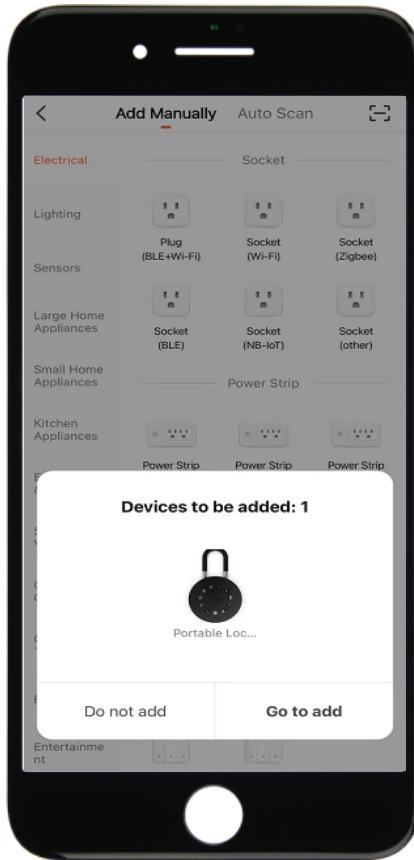

>4. Connecting, you need to wait for few seconds to let it finish.

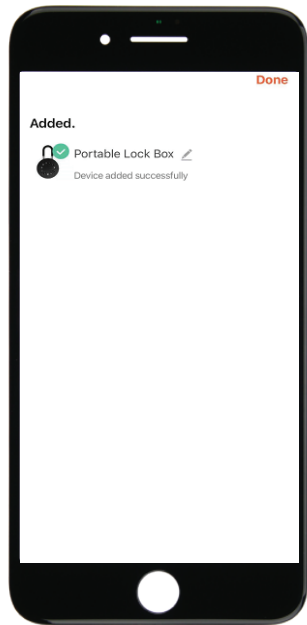
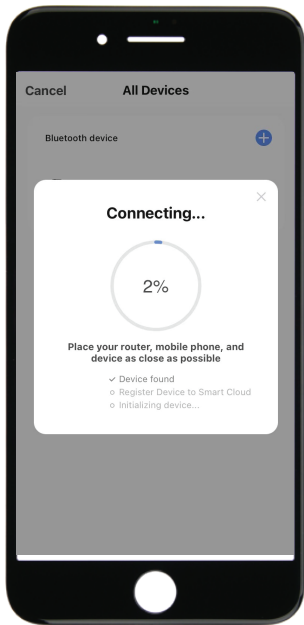

>5. Device added

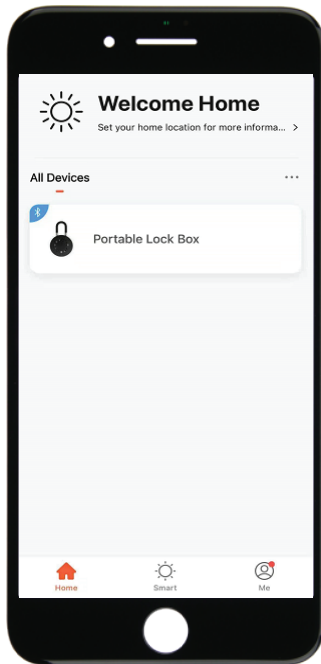

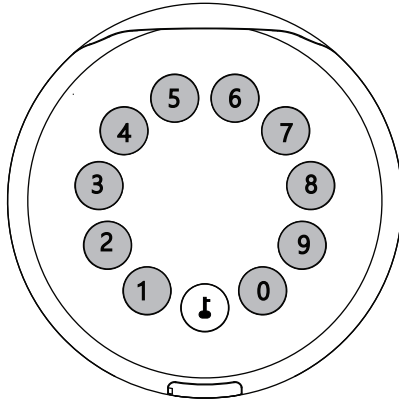

Step 4>Change Admin Password-Initial Admin Password:123456

>1. Press  and hold for 3 beeps



>2. Right after the 3 beeps please key in:

Initial Admin code 123456 +  +new admin code+  +new admin code again + , when you hear a long beep with green light, the new admin password has been set.

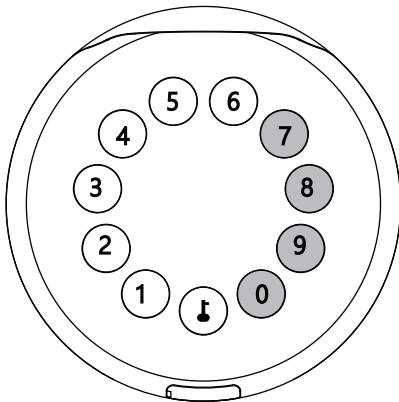

Mechanical Instructions

Password & Factory Mode:

1. Password Length

☒ Password must be 6 digits (no more no less)

2. Add User Password

☒ Tap **⏻** + 0 + **⏻** until the blue light blinks

>. Enter admin password + **⏻**

>. Enter new user password + **⏻**

>. Enter new user password again and press **⏻**

>. When the **⏻**(Enter button) blinks in green, user password has been set.

3. Delete User Password

☒ Tap **⏻** + 2 + **⏻** until the blue light blinks

>. Enter admin password and press **⏻**

>. Enter the user password you wish to delete and press **⏻**

>. Enter the user password again and press **⏻**

>. When the **⏻** (Enter button) blinks in green the password has been deleted.

4. Delete All User Password

☒ Tap **⏻** + 00000 + **⏻** until the blue light blinks

>. Enter admin password and press **⏻**

>. When the **⏻** (Enter button) blinks in green, all user passwords have been deleted.

5. Virtual digits-Anti Peeping

☒ Add any digits before and after the correct password the LockBox unlock as always

6. System Lockdown

☒ LockBox will Lockdown for 5 minutes if entering wrong password continuously 5 times.

7. Reset Factory Mode

☒ Use the reset tool press and hold the reset button for 5 seconds until a long beep.

Bluetooth broadcasting & re-connecting:

☒ Bluetooth will turn to sleep mode and lights out if no operations within 1 minute.

☒ Touch any key to activate the Bluetooth, LockBox will get reconnected again with App.

App Instructions

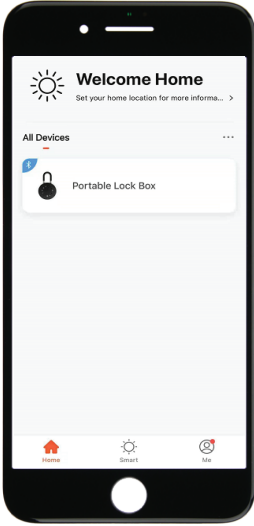

- ☑ You will see all devices and rooms on the home page.
- ☑ Tap the Device to start operating.
- ☑ Tap "Me" at the bottom to manage your home.

- ☑ Touch the lock sign to unlock and lock.
- ☑ Tap  to check the alarm records.
- ☑ Tap "Members" to add or delete members.
- ☑ Tap "Opening Logs" to check opening logs.
- ☑ Tap "Intelligent Linkage" to turn on and off go home mode.
- ☑ Tap "Setting" to manage passwords

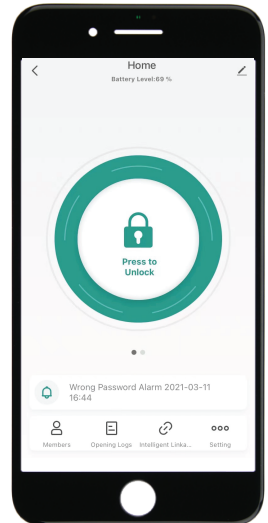

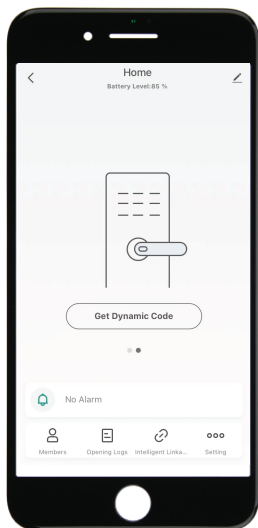

☑ Tap “Get Dynamic Code” to get a code.

☑ Tap “Copy Code” and send it to friend or family.

☑ Tap  to edit your personal information.

☑ Tap “+” to add family member or others.

☑ Tap added members to edit member’s information.

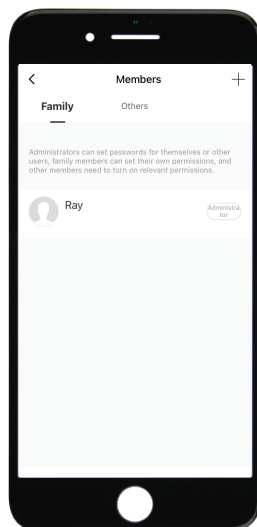

☑ You will find out when and whom unlocked the LockBox.

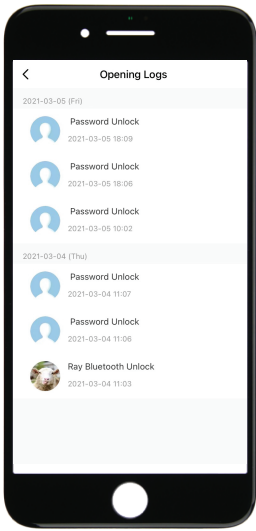

☑ Tap the green bar and save to turn on the function.

☑ Tap the orange bar and save to turn on the function.

☑ You will get notification if user unlocked with Bluetooth

☑ Go to "Me" homepage and go to message center to check the records.

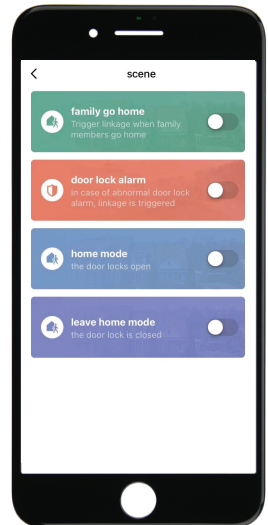

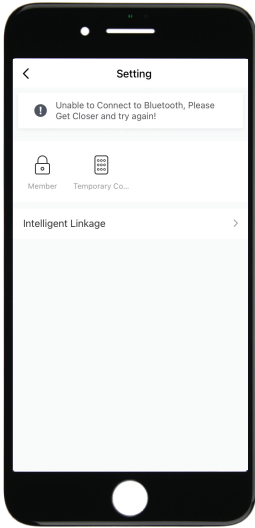

- ☑ Tap "Member" to manage members' information.
- ☑ Tap "Temporary Code" to manage online and offline codes.

- ☑ Tap "One-Time Password" under Online Password to set an online one-time code.
- ☑ Tap "Add online Periodic Code" under Online Code to set an online code which will be available in a period of time.
- ☑ Tap "One-Time Password" under Offline Password to generate an one-time offline code which will be a 10 digits code and use it when the device is offline.
- ☑ Tap "Add Offline Periodic Code" under Offline Code to generate an offline code (10 digits) which will be available for a period of time, and use it when the device is offline or Bluetooth disconnected with device.
- ☑ Tap "Clear Code" to generate a code (10 digits) which will be able to clear single or all the offline codes.
- ☑ Please note if the code less than 10 digits you need to regenerate a new code, the code must be 10 digits.

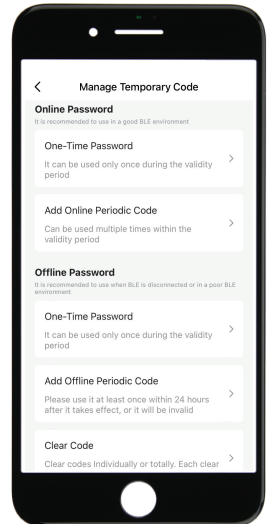

OMUARK

WWW.OMUARK.COM